

Preparation

**Part Number: PTS18-60060**

**Kit Contents**

Item #	Quantity Reqd.	Description
1	1	Stainless Steel Exhaust Tip
2	1	Aluminum Bushing
3	1	Stainless Steel Clamp
4	1	Zinc Plated Lock Nut
5	1	Installation Instructions

**Hardware Bag Contents**

Item #	Quantity Reqd.	Description
None		

**Additional Items Required For Installation**

Item #	Quantity Reqd.	Description
None		

**Conflicts**

--

**Recommended Tools**

<b>Personal &amp; Vehicle Protection</b>	<b>Notes</b>
None	
<b>Special Tools</b>	<b>Notes</b>
None	
<b>Installation Tools</b>	
Ratchet	
Socket	14 mm Deep Well Socket
Torque Wrench	10 lbf-ft
Rubber Mallet	
Non-scratch Cloth	
Wiping Cloth	
<b>Special Chemicals</b>	
Glass Cleaner	Dealer Installed
Approved Cleaner	VDC Installed

**General Applicability**

--

**Recommended Sequence of Application**

Item #	Accessory
1	Exhaust Tip





\*Mandatory

**NOTE:** Part number of this accessory may not be the same as the part number shown.

**Vehicle Service Parts** (may be required for reassembly)

Item #	Quantity Reqd.	Description
1		
2		
3		

**Legend**

	<b>STOP:</b> Damage to the vehicle may occur. Do not proceed until process has been complied with.
	<b>OPERATOR SAFETY:</b> Use caution to avoid risk of injury.
	<b>CAUTION:</b> A process that must be carefully observed in order to reduce the risk of damage to the accessory/vehicle and to ensure a quality installation.
	<b>TOOLS &amp; EQUIPMENT:</b> Used in Figures calls out the specific tools and equipment recommended for this process.

**Procedure**

Care must be taken when installing this accessory to ensure damage does not occur to the vehicle. The installation of this accessory should follow approved guidelines to ensure a quality installation.

These guidelines can be found in the "Accessory Installation Practices" document.

This document covers such items as:-

- Vehicle Protection (use of covers and blankets, cleaning chemicals, etc.).
- Safety (eye protection, rechecking torque procedure, etc.).
- Vehicle Disassembly/Reassembly (panel removal, part storage, etc.).
- Electrical Component Disassembly/Reassembly (battery disconnection, connector removal, etc.).

Please see your Toyota dealer for a copy of this document.

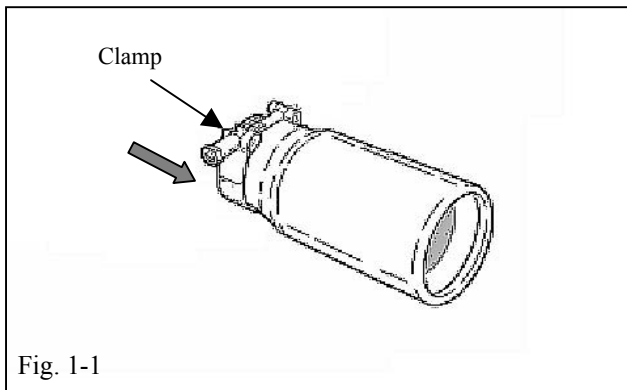

**1. Installation.**

- (a) Make sure the vehicle's tail pipe is free from dirt and debris.
- (b) Remove exhaust tip from box and set on a soft surface to prevent scratching.
- (c) Slide the Stainless Steel clamp over the stainless steel exhaust tip inlet as shown. (Fig 1-1)

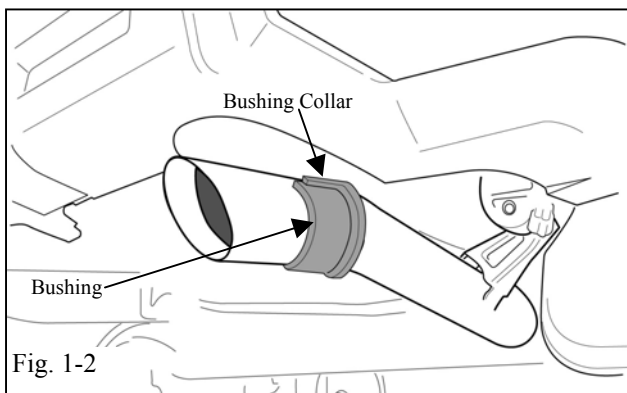

- ⚠ (1) Locate the bolt of the clamp at the top of the exhaust tip inlet with the bolt facing toward the left (driver side) side of the vehicle. (Fig. 1-1)

- ⚠ (d) Place bushing on tailpipe as shown. (Fig. 1-2)

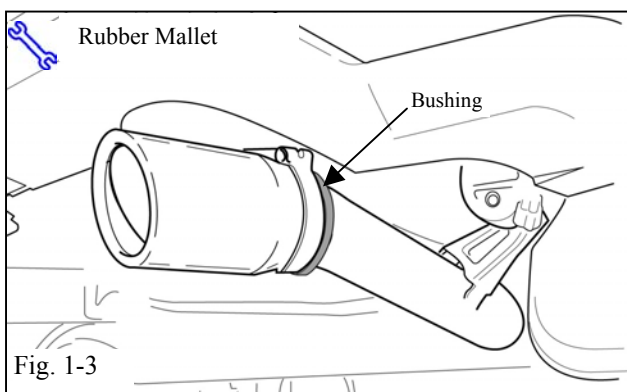

- (e) Slide exhaust tip assembly onto the tailpipe & bushing and align over the bushing collar as shown. (Fig. 1-3)

- (1) If necessary, a rubber mallet may be used to aid installation.

**NOTE:** The bushing is designed to assure a tight fit between the exhaust tip and tailpipe. It is also designed to prevent the clamp from sliding off the exhaust tip.

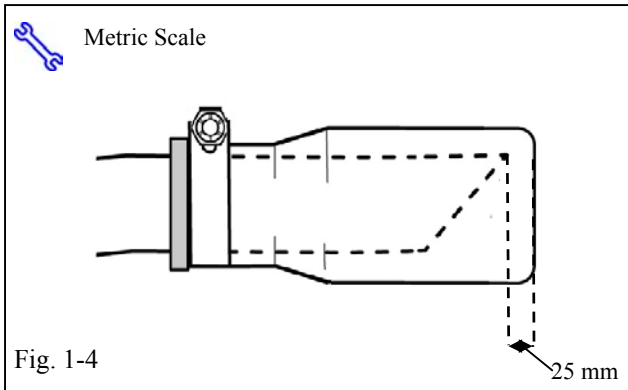

- (2) Adjust the exhaust tip so there is approximately a 25 mm gap between the top of the tailpipe and the outside edge of the exhaust tip as shown. (Fig. 1-4)

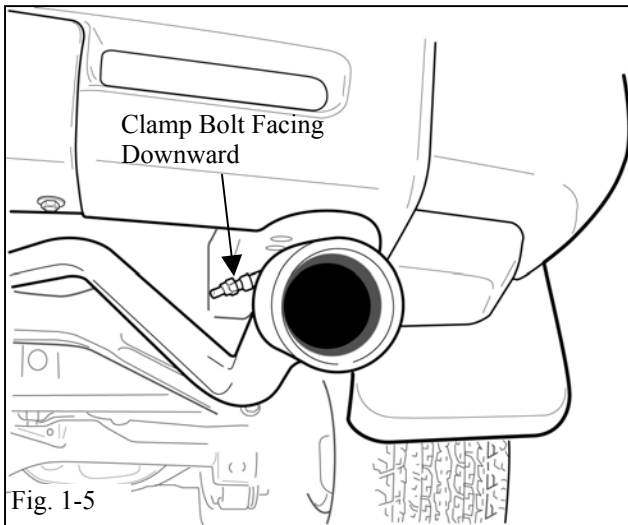

- (3) To prevent interference with the frame adjust the clamp bolt so that is not horizontal and is slightly facing downward as shown. (Fig. 1-5 & 1-6)

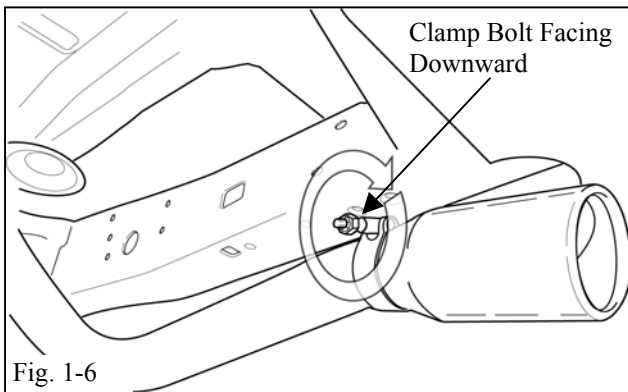

- (f) Once the tip, clamp & bushing are all positioned correctly and the alignment seems accurate, tighten the clamp nut as shown. (Fig. 1-6)

- (g) Torque clamp nut to 10 lbf-ft (8 lbf-ft min/12 lbf-ft max)

- (h) Clean exhaust tip with glass cleaner or approved cleaner and non-scratching cloth

**TOYOTA FJ Cruiser MY-2006 STAINLESS STEEL EXHAUST TIP**  
Checklist - these points **MUST** be checked to ensure a quality installation.

<u>Check:</u>	<u>Look For:</u>
<p><u>Accessory Function Checks</u></p> <p><input type="checkbox"/> Correct part number has been installed.</p> <p> <input type="checkbox"/> Nut Torque</p> <p><input type="checkbox"/> Tip Alignment</p>	<p>Verify part number on package.</p> <p>Nut Torque should be 10 lbf-ft (8 lbf-ft min/12 lbf-ft max).</p> <p>25 mm gap between the top of the tailpipe and the outside edge of the exhaust tip.</p>
<p><u>Vehicle Function Checks</u></p> <p><input type="checkbox"/> Rattle or vibration</p>	<p>Start engine and check for rattle or vibration of exhaust tip</p>